

OutBack Power Systems

MATE2M

System Controller and Display

Installation and User Manual



Please check our website at www.outbackpower.com for the latest product information

1.0 INTRODUCTION	4
1.1 FEATURES	4
1.2 INSTALLATION	5
2.0 BASIC OPERATION	5
2.1 POWER UP	5
2.2 NAVIGATION	6
2.2.1 Menu Structure	6
2.2.2 MATE2M Buttons	6
2.2.3 ‘SOFT’ Keys	7
2.2.4 The ‘INV’ Hot Key	8
2.2.5 The ‘AC IN’ Hot Key	8
2.3 COMMON SCREENS	10
2.3.1 The Main Screen	10
2.3.2 Summary Screens	10
2.3.3 Status Screens	11
2.4 SETUP MENU	11
2.4.1 Starting and stopping an EQ cycle	11
2.5 DISPLAY MENU	12
2.5.1 Backlight adjustment	12
2.5.2 Setting the clock	12
2.5.3 Communications Options	13
3.0 ADVANCED MENU	14
4.0 USING THE MATE2M WITH A HUB	15
5.0 MATE2M ADVANCED GENERATOR START MODE	16
5.1 ADVANCED GENERATOR START MODE	16
5.1.1 AGS Setup	17
5.1.2 Quiet Time	18
5.1.3 Voltage Start	18
5.1.4 Load Start	19
5.1.5 Must Run	19
5.1.6 Exercise	20
6.0 MENU MAP	21
7.0 MENU MAP OVERVIEW	32
8.0 TROUBLESHOOTING	37
REGISTER YOUR PRODUCTS!	39

1.0 Introduction

The OutBack MATE2M is a complete system controller and display for the OutBack FX inverter/charger. It provides a display of the operation as well as allows for control and adjustment of the product setpoints. The OutBack MATE2M also coordinates the operation of the entire inverter / charger system to maximize the performance and to prevent multiple products from conflicting.

Through the use of an OutBack HUB communication manager a single OutBack MATE2M is able to connect to multiple FX inverter/chargers and other OutBack products. A maximum of ten OutBack products will be able to be connected to a single MATE2M via a HUB using CAT 5 type Ethernet cabling with 8 wire RJ45 modular connectors.

1.1 Features



LCD Display

Four line, 80 character backlit LCD display with alphanumeric and graphic displays

Control Keypad

Six backlit silicone membrane keys – dedicated Inverter and AC input “hot” keys for control & 4 soft keys

Status Indicators

Two LED indicators: *Green = Inverter status* *Yellow = AC Input status*

Communication Protocol

Proprietary OutBack Multi-drop network using the OutBack HUB.

Interconnecting Cable

Standard CAT 5 PC network cable with RJ45 modular connectors / wired as non-crossover

Maximum Cable Length

The maximum distance that has been tested is 1000 feet of cable in an office / commercial building with success.

Optional PC computer interface

RS232 Opto-Isolated DB9 serial communication port

1.2 Installation

The OutBack MATE2M is designed for recessed panel or wall mounting in an indoor location. Keep the MATE2M out of direct sunlight to make the display easier to view.

The cabling from the MATE2M to the FX inverter/charger or HUB is standard CAT5 type computer cable. Standard Ethernet CAT5 cable, can be found at any home improvement or computer store. Consult your local inspector for specific installation requirements. The current and voltage in the communication cable is limited to less than 30 volts DC and is considered to be a "limited energy circuit". No conduit should be required. Either CAT5 or CAT5e cable can be used. The MATE2M is shipped with 50' of cable with the correct RJ45 connectors already installed. Longer or shorter cables can be purchased pre-made or custom length cable can be made on site. Follow the cable manufactures' instructions when choosing connectors and crimping tools.



NOTE: The maximum tested cable length from the MATE2M to an OutBack product is 1000 feet (300 meters). This distance can vary depending on cable routing and location. MATE2M cable that is run in a 'noisy' environment (ex. A MATE2M cable run in conduit with AC wiring) will suffer from signal degradation, impacting the maximum length the cable can be run without incurring transmission errors.

2.0 Basic Operation

2.1 Power Up

As soon as the MATE2M cable is plugged into a powered OutBack product, the MATE2M will power-up and display several information screens. After a greeting and copyright screen appears, the next screen displayed has the MATE2M Code and Screen Revisions (see below).

MOBILE
Code *a.aa*
Serial #XXXXXXXX
Screen EE *b.bb*

The MATE2M's operation and features are dictated by the code version. The serial number displayed matches the bar coded sticker on the MATE2M's main PCB. This can be viewed by removing the MATE2M's back cover. The Screen EE version refers to the menu system currently loaded in the MATE2M. All of the version and serial numbers should be referred to when contacting OutBack with MATE2M questions.

For an explanation of the differing code versions, see the **MATE firmware revisions** topic under **MATE Release Notes** on the **OutBack Power Systems User Forum** found at: <http://www.outbackpower.com/cgi-bin/Forum/ultimatebb.cgi>.

After the Version screen the MATE2M will display a connected devices screen (see below). If the MATE2M does not find the connected device, refer to the section [8.0 Troubleshooting](#)

MATE2M found an FX

Searching
for Devices
FX Found

MATE2M found no OutBack Product

Searching
for Devices
No Devices Found

2.2 Navigation

This section of the manual will cover how to use the buttons on the MATE2M to navigate the menus.



NOTE: The menu system displayed on the MATE2M will vary depending on the software version that the MATE2M was programmed with at the time of manufacturing or during its last software upgrade.

2.2.1 Menu Structure

The OutBack MATE2M uses a branching menu structure to display various OutBack products operation modes and status. The menus are divided by product type and are categorized by type of settings or information is being displayed.

An example of the menu structure is shown to the right. All the screens that show AC meters are grouped together in one menu tree allowing the user to find the required meter with a minimum of button presses.

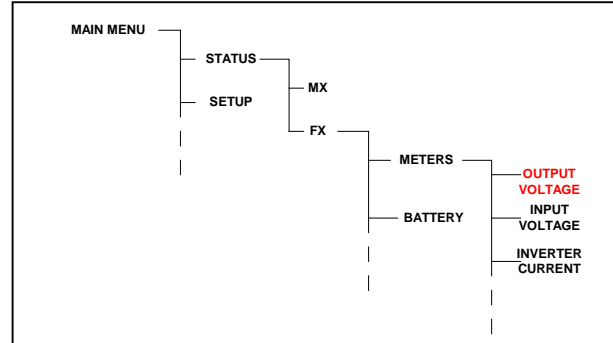

The top line of the MATE2M display will show the 'path' to the current menu; in this example it is STATUS/FX/METERS.

```
STATUS/FX/METERS-----
output                    122 vac
voltage
DOWN UP TOP PORT
```

2.2.2 MATE2M Buttons



The MATE2M uses a six button user interface to navigate the menus and to change setpoints of various OutBack products.

Two buttons are dedicated for the FX inverters and are labeled **ACIN** and **INV**. These buttons are special in that they can be pressed at any time anywhere in the MATE2M menu structure, and they take you to the same screens. For this reason they are referred to as 'hot' keys. Many common functions that need to be accessed often are found under the **ACIN** and **INV** button.

The four lower buttons under the LCD are called 'soft' keys and are used for navigating around the menus and changing values. Each 'soft' key has various functions dependent on the label directly above it on the lower line of the LCD.



NOTE: The lower line on the MATE2M is almost exclusively used for labels to the four soft keys below. This manual will denote soft key button presses as **<BUTTON>**, where **BUTTON** corresponds with the label displayed on the screen directly above the soft key.

2.2.3 'SOFT' Keys

The four buttons under the LCD are referred to as the 'soft' keys. Their operation is dependent on what their label says. The label is the word on the bottom line of the LCD directly above the button.

Soft keys used to navigate the menus are commonly labeled **<UP>**, **<DOWN>**, **<NEXT>**, **<BACK>**, or **<TOP>**.

Soft keys that change settings are labeled either with the change they will make, such as : **<OFF>**, **<AUTO>**, and **<ON>**, or if there are more than a couple values that the setting can be changed to, **<INC>** and **<DEC>** are used to mean *increase* and *decrease*, respectively.

```
STATUS/FX/METERS-P01
output:      119 vac
voltage
DOWN  UP    TOP    PORT
```

In this example, pressing **<DOWN>** will take you to the next setpoint screen in the SETUP/FX/INPUT menu.

```
SETUP/FX/INPUT---P00
Input setup
completed
TOP  SETUP  MAIN
```

In this example, pressing **<TOP>** will take you to the first setpoint screen in the SETUP/FX/INPUT menu. **<SETUP>** will return you to the SETUP/FX screen, and **<MAIN>** will take you back to the Main screen.

```
SETUP/FX/INPUT---P00
ac transfer   CORD
control
DOWN  CORD  GEN  PORT
```

In this example, pressing **<CORD>** will change the FX AC transfer control to **CORD** mode. Conversely, pressing **<GEN>** will change the FX AC transfer control to **GEN** mode.

```
SETUP/FX/INPUT---P00
ac1/grid     60 aac
limit
DOWN  INC  DEC  PORT
```

In this example, pressing **<INC>** or **<DEC>** will change the numerical value of the **ac1/grid limit** setting.

```
ADV/FX/AUX-----P00
aux output   Remote
function
DOWN  INC  DEC  PORT
```

In this example, there are multiple operating modes for the aux output function. Pressing **<INC>** or **<DEC>** will cycle through the available modes.

2.2.4 The 'INV' Hot Key

The OutBack MATE2M includes an **INV** "hot" key to allow direct control of the inverter from anywhere in the menu system. The **INV** key is located on the right side of the MATE2M LCD display. Pressing the **INV** key will take you to the **INVERTER CONTROL** menu section as shown below.

A green LED indicator is located above the **INV** key which flashes when the inverter is either in the search or power save modes, and is on continuously when full AC output voltage is available from the inverter. When the inverter is turned off or when the AC input source is being used, the green LED will not be illuminated.

When an OutBack HUB is employed, the **INVERTER CONTROL** options effect all FX inverters on the HUB.

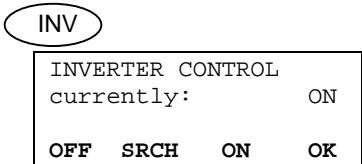

- <OFF>** Turns all the inverters connected to the MATE2M off
- <SRCH>** Causes the inverter to begin operating in the search mode if the AC load connected is smaller than allowed by the programming of the search function.
- <ON>** Turns all the inverters connected to the MATE2M on
- <OK>** Returns to the point in the menu system where you entered the **INVERTER CONTROL** screen

2.2.5 The 'AC IN' Hot Key

The OutBack MATE2M includes an **AC IN** "hot" key to allow direct control of the AC input from anywhere in the menu system. The **AC IN** key is located on the left side of the MATE2M LCD display.

Above the **AC IN** key is a yellow LED indicator which flashes when an AC source is available but not connected and which is on continuously when the AC source is connected and in use. If no AC source is connected the yellow LED indicator will remain off.

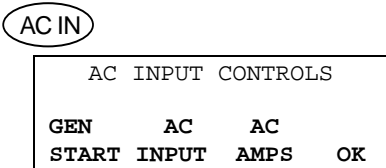

Pressing the **<AC IN>** key brings up the **AC INPUT CONTROLS** screen. This screen allows the user to adjust common AC input settings and modes. When an OutBack HUB is employed, the **AC INPUT CONTROLS** only effects the Master FX connected to PORT 1. The Master then echoes the command to all of its slaves.

- <GEN START>** Controls the MATE2M Advanced Generator Starting Mode. See Section [5.0 MATE2M Advanced Generator Starting](#).
- <AC INPUT>** Sets the input mode to CORD or GEN.
- <AC AMPS>** Allows the user to adjust shore cord AC input amps.

Continued on next page

```

GEN START CONTROL
Currently:      Auto
OFF  AUTO  ON   OK

```

Pressing the **<GEN START>** at the **AC INPUT CONTROLS** screen brings up the **GEN START CONTROL** screen. This screen allows the user to change the Advanced Generator Start (AGS) mode. Modes can only be changed when Advanced Generator Start is enabled (See section [5.0 Advanced Generator Start](#) for more information). When an OutBack HUB is employed, the **GEN START CONTROL** only effects the FX that has been programmed as the AGS PORT in the AGS menu.

- <OFF>** Manually overrides AGS mode and shuts off the generator
 - <AUTO>** Allows the MATE2M to automatically start and stop the generator according to the settings programmed in the AGS menu
 - <ON>** Manually overrides AGS mode and starts the generator
 - <OK>** Returns to the point in the menu system where you entered the **GEN START CONTROL** screen
-

```

AC INPUT SOURCE
currently:      CORD
GEN  CORD   OK

```

Pressing the **<AC INPUT>** key at the **AC INPUT CONTROLS** screen brings up the **AC INPUT SOURCE** screen. This allow the user to switch between shore cord or generator input modes.

- <GEN>** Forces the FX to use the generator input settings
 - <CORD>** Forces the FX to use the shore cord input settings.
 - <OK>** Returns to the point in the menu system where you entered the **AC INPUT SOURCE** screen
-

```

AC CORD AMPS  -----P01
Currently:    15.0 amps
MORE  LESS  PORT  OK

```

Pressing the **<AC AMPS>** key at the **AC INPUT CONTROLS** screen brings up the **AC CORD AMPS** screen. This screen allows the user to adjust the shore cord input size.

When the **<MORE>** is pressed, the amperage that the FX inverter will draw from the shore cord input will be increased.

<LESS> will reduce the amperage that the FX is allowed to draw off the shore cord.

When a stacked system and an OutBack HUB is employed, this screen only controls the FX pointed to by the **<PORT>** button, for more information on using the MATE2M with a HUB, please see section [4.0 USING the MATE2M with a HUB](#).

2.3 Common Screens

2.3.1 The Main Screen

```

AC POWER SYSTEM MENU

SUM- STATUS SET DIS
MARY METERS UP PLAY
    
```

After the power-up screens is the Main screen. It is the root, or home screen to the entire menu structure. If you get lost exploring the MATE2M's many screens, press the two left soft keys *simultaneously* to return to the Main Screen from anywhere in the menu system. Additionally, most menu branches end with a soft key labeled **<MAIN>**; pressing this button will return you to the Main screen.

2.3.2 Summary Screens

The Summary screens provided by the MATE2M summarize the current status of all the OutBack products connected to it. Summary screens can be accessed from the Main screen by pressing the **<SUMMARY>** button. Summary screens also pop up like a screen saver after a delay. Any MATE2M button pressed while the Summary screen is being displayed returns you to the screen that was active before the summary screen was displayed.

If the MATE2M has one or more FXs connected to it, an FX summary screen will be displayed. It shows 3 amp meters; AC LOADS, CHARGER, and AC Total.

```

AC LOADS 7 AMPS AC
CHARGER 2 AMPS AC
AC Total 9 AMPS AC
Battery GOOD 25.6V
    
```

```

AC LOADS 7 AMPS AC
    
```

The AC Loads meter displays the amount of power consumed by the users loads. It could be either the FX's inverting and supplying AC power to the loads, or the amount of power the loads are consuming from the AC input source, such as the shore cord or generator. In this example it is 7 amps AC.

```

CHARGER 2 AMPS AC
    
```

The CHARGE meter shows the amount of power that the FX is using from an AC input source to charge the batteries. In this example it is 2 amps AC.

```

Battery GOOD 26.5V
    
```

The last line is for displaying battery state and voltage. Battery state is displayed as GOOD, OK, and LOW depending on battery voltage. Below is a chart describing the battery voltage at which this state changes.

System Battery Voltage	LOW	OK	GOOD
24	<=11.4 VDC	11.5 to 12.4 VDC	>= 12.5 VDC
12	<= 22.8 VDC	23.0 to 24.8 VDC	>= 25.0 VDC

2.3.3 Status Screens

The Status menu that can be accessed by pressing **<STATUS METERS>** on the Main screen contains all the meters and mode displays for OutBack products that are connected to the MATE2M.

(See section [6.0 Menu Map](#) for locations of all of the status screens available.) Consult your specific OutBack product owner manual for an explanation of all the operating modes and meters.

The Status screens available differ by product type and revision. Typically it contains AC & DC meters, error, warning, and disconnect reasons. Pressing **<PG2>** brings up a second page of options.

<OK> on the second page will return you to the Main screen.

```

AC POWER SYSTEM MENU
SUM- STATUS SET DIS-
MARY METERS UP PLAY
    
```

```

STATUS/METERS MENU
Choose category:

METER BATT ERROR PG2
    
```

```

STATUS/METERS MENU
Choose category:

PG1 WARN DISCON OK
    
```



NOTE: Not all Status screens are applicable to all FX models. An example would be; none Grid-Tie FX may not display grid-tie parameters.

2.4 Setup Menu

The Setup screens allow the user to adjust basic setpoints for the MATE2M and FX inverters. Pressing **<SETUP>** from the Main screen brings up the SETUP menu.

```

SETUP INV CHGR MENU
select category:
                AC IN
SEARCH LBCO LIMT PG2
    
```

- <SEARCH>** Allows the user to adjust the FXs Search function.
- <LBCO>** Change the FXs Low Battery Cut Out voltage.
- <AC IN LIMT>** Allows the user to change the low and high voltage input windows for the shore cord input.
- <PG2>** Brings up the second page.
- <EQ>** Starts or stops an EQ cycle. See below.

```

SETUP INV/CHGR MENU
Choose category:

EQ                                OK
    
```

2.4.1 Starting and stopping an EQ cycle

```

EQUALIZE CONTROL

START  STOP      OK
    
```

Pressing the **<EQ>** key from the **SETUP INV CHGR MENU** brings up the **EQUALIZE CONTROL** screen. This screen allows the MATE2M to issue system wide (global) charger commands.

When the **<START>** has been selected, two informational screen are displayed. The user then must answer **<YES>** before an equalize charging cycle is allowed to begin.

Once the equalizing process has started, you can stop it at anytime by selecting **<STOP>** from this same control screen.



NOTE: For a global charger command to work, all of the OutBack products must be connected to a HUB. The **CHARGER MODE CONTROL** effects both FX inverters *and* MX60 charge controllers. This requires that the FX and MX firmware versions support this feature (See section [8.0 Troubleshooting](#) if this command fails to function).

2.5 Display Menu

The Display menu contains settings concerning the MATE2M. In the Display menu, the user can adjust the LCD display backlight options, set time and date, and adjust communications setpoints.

From the Main screen press **<DISPLAY>** to enter the Display menu

```
AC POWER SYSTEM MENU
SUM- STATUS SET DIS-
MARY METERS UP PLAY
```

The Setup Display screen displays the MATE2M code revision; in the example to the right it is 3.30.

```
SETUP DISPLAY-----
Mate code rev:      330
Choose category:
BLITE TIME COMM OK
```

<BLITE> This menu is for adjusting the LCD screens backlight. See 2.5.1 Backlight Adjustment for details.

<TIME> Allows the user to adjust time and date settings used by the MATE2M. See section 2.52 Setting the Clock.

<COMM> The communications menu allows the user to turn PC communications on or off (RS-232 equipped MATE2M only), debugging of communications errors, and repelling of OutBack devices connected to the MATE2M. See section 2.5.3. Communications Options for more details.

<OK> The OK button will return the user to the Main screen.

2.5.1 Backlight adjustment

<LEVEL> controls brightness and is adjustable from 0 to 100%.

<MODE> allows user to set the backlight to always off, auto-off after a time, or always on by selecting **<OFF>**, **<AUTO>**, or **<ON>**, respectively.

<TIME> sets the auto-off time limit from 1 to 60 minutes. This is how long the MATE2M waits after the last button press to turn off the backlight. Once the backlight has turned off, any button press on the MATE2M will turn it back on.

```
SETUP BLITE-----
Backlight controls
LEVEL MODE TIME OK
```

2.5.2 Setting the clock

Pressing **<DATE>** lets allows the user to change the date displayed by the MATE2M. The **<TIME>** is for changing the current time displayed by the MATE2M. The **<OK>** button returns you to the previous screen.

Correct time and date are required for the [MATE2M Advanced Generator Start mode](#) discussed in section 5.0 to operate correctly.

```
SETUP/MATE/CLOCK-----
Mo 1/01/03
12:00:00P
DATE TIME OK
```



NOTE: The MATE2M clock does **not** automatically adjust for daylight savings time.

2.5.3 Communications Options

<COMM> deals with MATE2M communication options. Pressing **<COMM>** brings up several options that can be changed.

<REPOLL> forces the MATE2M to 'rediscover' all the OutBack devices it is connected to. This is used any time an OutBack devices is moved or added to a HUB.

<PC> will enable or disable the RS232 communications port of the MATE2M. This setting must be enabled if you use any third party logging or control software.

```
SETUP/MATE/COMM-----
Choose category:

REPOLL PC DEBUG  OK
```

<DEBUG> allows communications errors involving the OutBack HUB to be tracked.

On the DEBUG screen, first press **<RSET>** to reset the error counting display; then press **<VIEW>** to bring up a list of HUB ports with a count of communications errors for each port.

In the example to the right, Port 4 has a large number of errors detected (04:025 means Port 4: showing 25 errors). Pressing any key will take you to the SETUP/MATE/COMM screen, which will allow the error counts to be reset using the **<RSET>** button. The DEBUG screen can be redisplayed by using the **<VIEW>** button, or the user can get back to the SETUP menu by using the **<BACK>** button.

```
SETUP/MATE/COMM-----
Comm. errors:

VIEW RSET          OK
```

```
00:000  01:000  02:000
03:000  04:025  05:001
06:001  07:001  08:001
09:001  10:001  2M:001
```

Use the information on the DEBUG screen to locate the problem device. Make sure that the problem device's DC breaker is on and that it is operating correctly. Check or replace CAT5 cables running from the HUB to that device.

3.0 Advanced Menu

The Advanced menu system is where most of the initial system settings are programmed. Because changing these settings could adversely effect how the system operates, the user must input a password to enter the advanced menus. The settings under the Advanced menu should only be changed by someone that has read and understands the specific products users manual.



NOTE: Not all Advanced menu screens are applicable to every model FX. An example would be a none Grid-Tie FX may not display grid-tie parameters, or allow their adjustment.

The Advanced menu is hidden and can only be accessed from the Setup menu. From the Main menu press **<SETUP>**. When the **SETUP INV / CHGR MENU** screen appears, press the middle two buttons *simultaneously* (The middle two buttons are labeled **<LBCO>** and **<AC IN LIMIT>** respectively)

```
AC POWER SYSTEM MENU
SUM- STATUS SET DIS-
MARY METERS UP PLAY
```

At the resulting warning screen, press any of the four soft keys to continue on to the password screen.

```
SETUP INV CHGR MENU
select category:
                AC IN
SEARCH LBCO LIMIT PG2
```

Using the **<INC>** and **<DEC>** buttons, enter the advanced menu password and press **<ENTER>**.

```
ADV/PASSWORD-----
Enter the password
                132
ENTER INC DEC EXIT
```

The Advanced menus allow the user to set most of the initial system setpoints for the FX, MX, and MATE. After entering the password choose the product you would like to change the Advanced settings for.

The FX Advanced menus have categories like:

- INV – Inverter setup
- CHGR – Charger setpoints
- GRID – Grid input setpoints
- GEN – Generator input setpoints
- AUX – FX Aux output settings
- STACK – FX stacking setup
- CAL – FX meter calibrations



NOTE: Not all Advanced menu screens are applicable to every model FX. An example would be a non Grid-Tie FX may not display grid-tie parameters, or allow their adjustment.

The MX Advanced menus only allow for the setup and control of the MX60s AUX output.

The Mate Advanced menus contain the settings for:

- AGS – Advanced Generator Starting

These advanced settings are covered in section [5.0 Advanced Generator Start Mode](#)

The Advanced Menu Password is 141

4.0 Using the MATE2M with a HUB

A HUB-4 or HUB-10 can be used to connect multiple OutBack products to the MATE2M. A HUB-10 communication manager allows a single MATE2M to control and monitor a maximum of ten OutBack products, while a HUB-4 is limited to four OutBack products.

A HUB has 4 to 10 ports labeled 1-10 for various OutBack products to be plugged into.

When setting-up a HUB based system to work with the MATE2M, several guidelines must be followed:

A system comprised of all FX inverters must have the Master FX plugged into Port 1 of the HUB.

A system comprised of all MX charge controllers must have one of the MXs plugged into Port 1.

A system that has a mix of FXs and MXs must have the Master FX plugged into Port 1 and have the slave FXs plugged into the next lowest numbered Ports. For example, if a system comprised of 4 FX's and 2 MX's, the FXs must be plugged into Ports 1 – 4; the MXs can be plugged into any Port numbered greater than 4.

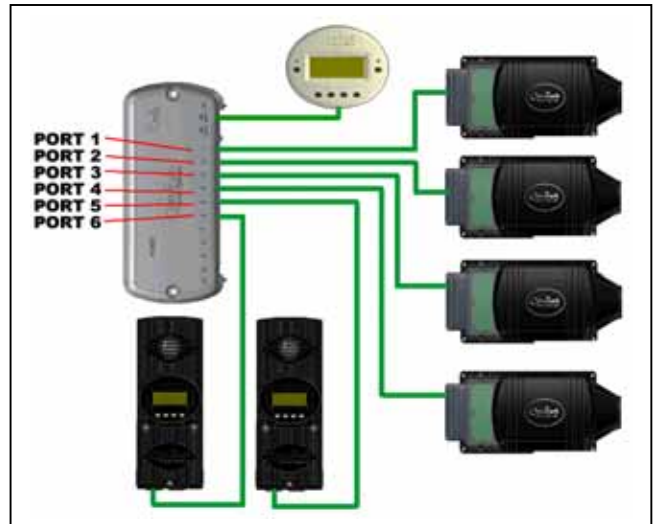

When first powering-up the system, make sure all of the OutBack products are plugged into the HUB and powered before plugging the MATE2M into the HUB.

When a MATE2M that is plugged into a HUB powers up, it will first display that it has found the HUB.

Searching
for Devices
HUB Found

Next it will display the Port Assignment screen. This screen shows all of the connected devices and what Port that they are found on. If a connected device is not shown on this screen, check that it is connected correctly and is powered up. Then either unplug and plug the MATE2M back into the HUB or use the REPOLL command described in the [Communications Options](#) section to force the MATE2M to rediscover all devices.

Port Assignment			
1>FX	2>FX	3>FX	4>FX
5>MX	6>MX	7>--	8>--
9>--	10>--	2M>--	

Once powered up, the MATE2M operation with a HUB is basically the same as when the MATE2M is directly connected to an OutBack product.

```
STATUS/FX/METER-----P01
Output                120vac
Voltage
DOWN UP TOP PORT
```

The most important difference is the Port Identifier in the upper right hand corner of most screens. The number after the **P** in **P01** tells you that the meter reading currently displayed on the screen is coming from the FX in Port 1. By pressing the **<PORT>** button, you can cycle through all of the devices on the system.



NOTE: When the user is in a menu that is dedicated to FXs, only FX Ports can be cycled through by pressing the **<PORT>** button. Using the above system as an example, only **P01**, **P02**, **P03**, and **P04** will be displayed when the **<PORT>** button is pushed while in a FX menu. Conversely, only **P05** and **P06** will be displayed when the **<PORT>** button is pressed in an MX menu.



NOTE: Any time a new device is plugged into a HUB or an existing device is moved to a different Port, the MATE2M must be either unplugged and plugged back into the HUB or the REPOLL command described in the [MATE2M Setup](#) section must be used to force the MATE2M to rediscover all devices.

5.0 MATE2M Advanced Generator Start Mode

The settings for all of the MATE2M Advanced Generator Start are under the **ADVANCED** menu. The Advanced menu is hidden and can only be accessed from the Setup menu. From the Main menu press **<SETUP>**.

When the **SETUP INV / CHGR MENU** screen appears, press the middle two buttons **simultaneously** (The middle two buttons are labeled **<LBCO>** and **<AC IN LIMIT>** respectively)

At the resulting warning screen, press any of the four soft keys to continue on to the password screen.

Using the **<INC>** and **<DEC>** buttons, enter the advanced menu password and press **<ENTER>**.

Choose **<MATE>** at the Advanced menu screen.

Choose **<AGS>** to begin Advanced Generator Start setup.

```
AC POWER SYSTEM MENU
SUM- STATUS SET DIS-
MARY METERS UP PLAY
```

```
SETUP INV CHGR MENU
select category:
                AC IN
SEARCH LBCO LIMIT PG2
```

```
ADV/PASSWORD-----
Enter the password
                132
ENTER INC DEC EXIT
```

```
ADV-----
Choose product:
FX MX MATE MAIN
```

```
ADV/MATE-----
Choose category:
AGS                ADV
```

5.1 Advanced Generator Start Mode

Advanced Generator Start (AGS) Mode utilizes the AUX output found on FX inverters and is compatible with any 2 wire start generator. AGS allows the user to choose a variety of conditions that will start a generator by energizing the FX AUX output.

AGS will start the generator anytime one or more of the Gen Start conditions are true, and will stop the generator only when all of the conditions are false.

After AGS starts a generator, the FX must connect to the generator within a 5 minute window. If the FX fails to connect within 5 minutes, a Genstart error is displayed by the MATE2M, and all subsequent AGS conditions will be ignored until the AGS mode has been reset. AGS mode can be reset by using the **GEN START CONTROL** found by pressing the **<ACIN>** button twice. Pressing **<OFF>** and then **<AUTO>** resets all AGS errors or faults. The generator can also be manually started using the **GEN START CONTROL** screen by pressing **<ON>**. If the user wants the generator to auto stop after a charge cycle is complete, the user can press the **<AUTO>** button after the generator has been started by pressing **<ON>**.

The following is a discussion of all the AGS setup parameters and start condition available to the user:

5.1.1 AGS Setup

The AGS Setup menu contains the following general settings that define how the rest of the AGS routines will work:

AGS Port:

The MATE2M can use any AUX output of an FX that is connected to it either directly or via an OutBack HUB-4 or HUB-10. If a HUB is used, the MATE2M must be told what Port that the desired FX resides on. If no HUB is used and the MATE2M is directly plugged into an FX, then the AGS Port needs to be set to 0 (zero). If a HUB is used, the numbered jack that the desired FX is connected to on the HUB should be set as the AGS Port.

MATE/AGS/SETUP-----
Ags port: 0
DOWN AGS INC DEC

Example:

A MATE2M is connected to a HUB-10 that has four FXs and three MXs connected to it. The FXs are plugged into Ports 1 – 4, as labeled on the HUB, and the MXs are plugged into Ports 5 – 7. The FX connected to Port #3 will have its AUX output wired to the generator, so the AGS Port should be set to '3'.

AGS Control:

This screen allows the AGS mode to be changed. Pressing **<CHANGE>** brings up a screen that allows the user to switch AGS from Manual to Auto.

An **<OFF>** de-energizes the FX AUX output and stops the generator regardless of any AGS setting; this is displayed as MAN – OFF.

An **<AUTO>** will allow the AGS settings to start and stop the generator automatically, and is displayed as either AUTO – ON (when the generator is running), or AUTO – OFF (when the generator is stopped).

An **<ON>** will energize the FX AUX output and start the generator regardless of any AGS setting, this is displayed as MAN – ON.

ADV/MATE/AGS/SETUP----
Ags control: MAN-Off
DOWN UP CHANGE

GEN START CONTROL
currently: MAN-Off
OFF AUTO ON OK

AGS Enabled:

This is the overall control for AGS. If AGS is not enabled, none of the AGS settings or controls will work.

ADV/MATE/AGS/SETUP----
Ags enabled: NO
DOWN UP NO YES

DC Genset:

A Yes means that you have a DC generator and that AGS routines which normally stop the generator upon the FX going to Float or Silent will instead stop the generator when the **VDC Genstop** setting is reached.

ADV/MATE/AGS/SETUP----
Dc genset: NO
DOWN UP NO YES

VDC Genstop:

This voltage setting will terminate a Voltage Start Genstart when the battery voltage remains above it for 15 min regardless of the **DC Genset** setting.

ADV/MATE/AGS/SETUP----
Vdc genstop: 38.0 vdc
DOWN UP INC DEC

5.1.2 Quiet Time

Quiet Time is a time period during which the MATE2M will not allow most AGS settings to start the generator. This is usually set-up as night time when a running generator would be an annoyance. Quiet Times can be set individually for weekday and weekend, and consist of a Quiet Time Start and a Quiet Time Stop.

WEEKDAY START:

Weekday Quiet Time start is the beginning of the quiet time period for Mon - Fri, most AGS start conditions will be stopped at this time. Press **<CHANGE>** to adjust the hour and minutes settings.

ADV/MATE/AGS/QT-----
weekday: 12:00A
quiet time start
DOWN AGS CHANGE

WEEKDAY STOP:

Weekday Quiet Time stop is the end of the quiet time period for Mon - Fri. Press **<CHANGE>** to adjust the hour and minutes settings.

ADV/MATE/AGS/QT-----
weekday: 12:00A
quiet time stop
DOWN UP CHANGE

WEEKEND START:

Weekend Quiet Time start is the beginning of the quiet time period for Sat & Sun, most AGS start conditions will be stopped at this time. Press **<CHANGE>** to adjust the hour and minutes settings.

ADV/MATE/AGS/QT-----
weekend: 12:00A
quiet time start
DOWN UP CHANGE

WEEKEND STOP:

Weekend Quiet Time stop is the end of the quiet time period for Sat & Sun. Press **<CHANGE>** to adjust the hour and minutes settings.

ADV/MATE/AGS/QT-----
weekend: 12:00A
quiet time stop
DOWN UP CHANGE

5.1.3 Voltage Start

There are three voltage start setpoints in AGS Mode that the user can adjust. After a generator is started due to a Voltage Start setting, it will be stopped when the FX reaches Float or Silent mode, or based on the **VDC Genstop** setting in AGS Setup menu previously explained.

24 Hour voltage setpoint:

If the battery voltage falls below this setpoint, a 24 hour timer starts to count down. On reaching zero, a genstart is sent to the FX inverter unless it is currently Quiet Time.

ADV/MATE/AGS/VSTART--
Volt start 24.4 vdc
24 hr setting
DOWN AGS INC DEC

2 Hour voltage setpoint:

If the battery voltage falls below this setpoint, a 2 hour timer starts to count down. On reaching zero, a genstart is sent to the FX inverter unless it is currently Quiet Time.

ADV/MATE/AGS/VSTART--
Volt start 23.6 vdc
2 hr setting
DOWN UP INC DEC

2 Minute voltage setpoint:

If the battery voltage falls below this setpoint, a 2 minute timer starts to count down. On reaching zero, a genstart is sent to the FX inverter **even** if it is currently Quiet Time.

ADV/MATE/AGS/VSTART--
Volt start 22.0 vdc
2 min setting
DOWN UP INC DEC

5.1.4 Load Start

Load Start will start a generator whenever the total system AC Load exceeds the setpoint for the programmed amount of time. The generator will then be stopped when the AC load has dropped below a Load Stop setpoint for a programmed amount of time.

Load Start KW:

An AGS genstart will be issued when the total AC load of all the FXs connected to the MATE2M exceeds this setting for the amount of time set with **Load Start Delay**. A zero disables any load start function. **<INC>** and **<DEC>** adjusts this setting between 1 – 50kW.

ADV/MATE/AGS/LS-----			
Load start	0 kw		
DOWN	AGS	INC	DEC

Load Start Delay:

This setting is the delay time that the total system AC load must remain above **Load Start kW**, before the generator is started. It is adjustable from 1 to 240 minutes.

ADV/MATE/AGS/LS-----			
load start	1 min		
delay			
DOWN	UP	INC	DEC

Load Stop KW:

An AGS genstop will be issued when the total AC load of all the FXs connected to the MATE2M fall below this setting for the amount of time set with **Load Stop Delay**. This setting excludes any FX charger current for its AC load calculation. Only when the power being provided to the FXs' AC output falls below this setting, will the generator be stopped.

ADV/MATE/AGS/LS-----			
Load stop	0 kw		
DOWN	UP	INC	DEC

Load Stop Delay:

This setting is the delay time that the total system AC load must remain below **Load Stop kW**, before the generator is stopped. It is adjustable from 1 to 240 minutes.

ADV/MATE/AGS/LS-----			
load stop	1 min		
delay			
DOWN	UP	INC	DEC

5.1.5 Must Run

Must Run Time is a daily time period that the MATE2M will command the generator to run every day. Must Run Times can be set individually for weekday and weekend, and consist of a Must Run Start time and a Must Run Stop time. Setting Must Run start and stop times to the same time, disables the Must Run function.

WEEKDAY START:

Weekday Must Run start time is the beginning of the time period, Mon - Fri, that the generator will be forced to run. Press **<CHANGE>** to adjust the hour and minutes settings.

ADV/MATE/AGS/MR-----		
weekday:	12:00A	
must run start time		
DOWN	AGS	CHANGE

WEEKDAY STOP:

Weekday Must Run stop time is the end of the Must Run time period for Mon - Fri. Press **<CHANGE>** to adjust the hour and minutes settings.

ADV/MATE/AGS/MR-----		
weekday:	12:00A	
must run stop time		
DOWN	UP	CHANGE

WEEKEND START:

Weekend Must Run start time is the beginning of the time period, Sat & Sun, that the generator will be forced to run. Press **<CHANGE>** to adjust the hour and minutes settings.

ADV/MATE/AGS/MR-----		
weekend:	12:00A	
must run start time		
DOWN	UP	CHANGE

WEEKEND STOP:

Weekend Must Run stop time is the end of the Must Run time period for Sat & Sun. Press **<CHANGE>** to adjust the hour and minutes settings.

ADV/MATE/AGS/MR-----		
weekend:	12:00A	
must run stop time		
DOWN	UP	CHANGE

5.1.6 Exercise

An Exercise time can be set by choosing a day of the week (Sun – Sat), a start time of day (12AM – 11:59PM), and a exercise period (1 – 240 minutes). On the first occurrence of the chosen day of the week each month, at the programmed start time, the generator will start and run for the programmed period.

EXERCISE START DAY (exstartday):

This is the day of the week that the generator will start on. This can be set to Mon – Fri, and Sat or Sun, depending on what day each month a generator exercise period should be run. The setting “- -” disables any exercise period.

ADV/MATE/AGS/EX-----
exstartday: --
DOWN AGS INC DEC

EX START TIME:

This setting controls at what time on the **Exercise Start Day** the generator will start it's exercise period. Press **<CHANGE>** to adjust the hour and minutes settings.

ADV/MATE/AGS/EX-----
Ex start time: 12:00A
DOWN UP CHANGE

EX PERIOD:

Ex Period is how long a generator exercise period will be. **<INC>** and **<DEC>** can change the value between 1 – 240 minutes.

ADV/MATE/AGS/EX-----
Ex period: 15 min
DOWN UP INC DEC

6.0 Menu Map



Variable “Soft” Keys

each one of the soft keys corresponds to a word on the bottom line of the LCD display

The menu system displayed on the MATE will vary depending on the software version that the MATE was programmed with at the time of manufacturing or during its last software upgrade.

The following pages give a basic idea of the menu structure and how you navigate through the menu system to the different programming levels. Some changes from these specific displays may be present in your installation.

CONTROL KEYS

Inv Hot Key

INV

```

INVERTER CONTROL
currently:      ON
OFF  SRCH  ON  OK
    
```

AC IN Hot Key

AC IN

```

AC INPUT CONTROL
GEN  AC  AC
START INPUT AMPS  OK
    
```

```

GEN START CONTROL
currently:  MAN-OFF
OFF  AUTO  ON  OK
    
```

```

AC INPUT SOURCE
currently:  Cord
GEN  CORD  OK
    
```

```

AC CORD AMPS-----P00
Currently: 30.0 amps
MORE  LESS  PORT  OK
    
```

Summary Screens

```

MAIN-----
6:54:42P
SUM- STATUS SET DIS
MARY METERS UP PLAY
    
```

```

ACLOADS  0 AMPS AC
CHARGER   0 AMPS AC
ACTOTAL   0 AMPS AC
Battery Good 25.4V
    
```

```

-----
MX CHARGER. . . . .
Battery      25.6V
    
```

STATUS MENU

METERS

```

MAIN-----
6:54:42P
SUM- STATUS SET DIS
MARY METERS UP PLAY
    
```

```

STATUS/FX/PAGE1-----
choose category:
METER BATT ERROR PG2
    
```

```

INVERT      P00
inv 0.0kw
chg 0.0kw buy 0.0kw
DOWN STATUS PORT
    
```

```

STATUS/FX/METERS-P00
output      122 vac
voltage
DOWN UP TOP PORT
    
```

```

STATUS/FX/METERS-P00
input      122 vac
voltage
DOWN UP TOP PORT
    
```

```

STATUS/FX/METERS-P00
inverter   0.0 aac
current
DOWN UP TOP PORT
    
```

```

STATUS/FX/METERS-P00
charger    0.0 aac
current
DOWN UP TOP PORT
    
```

```

STATUS/FX/METERS-P00
input      0.0 aac
current
DOWN UP TOP PORT
    
```

```

STATUS/FX/METERS-P00
FX firmware 50
revision
DOWN UP TOP PORT
    
```

```

STATUS/FX/METERS-----
end of meter menu
UP TOP STATUS
    
```

BATTERY

```

MAIN-----
6:54:42P
SUM- STATUS SET DIS
MARY METERS UP PLAY
    
```

```

STATUS/FX/PAGE1-----
choose category:
METER BATT ERROR PG2
    
```

```

STATUS/FX/BATT---P00
battery    25.0 vdc
actual
DOWN STATUS PORT
    
```

```

STATUS/FX/BATT---P00
battery    25.0 vdc
temp compensated
DOWN UP TOP PORT
    
```

```

STATUS/FX/BATT---P00
absorb     28.8 vdc
setpoint
DOWN UP TOP PORT
    
```

```

STATUS/FX/BATT---P00
absorb     01.5 hrs
time remaining
DOWN UP TOP PORT
    
```

```

STATUS/FX/BATT---P00
float      26.8 vdc
setpoint
DOWN UP TOP PORT
    
```

```

STATUS/FX/BATT---P00
float      00.8 hrs
time remaining
DOWN UP TOP PORT
    
```

```

STATUS/FX/BATT---P00
refloat    25.0 vdc
setpoint
DOWN UP TOP PORT
    
```

```

STATUS/FX/BATT---P00
equalize   28.8 vdc
setpoint
DOWN UP TOP PORT
    
```

```

STATUS/FX/BATT---P00
equalize   02.0 hrs
time remaining
DOWN UP TOP PORT
    
```

```

STATUS/FX/BATT---P00
batt temp. 255
(not in degree C/F)
DOWN UP TOP STATUS
    
```

```

STATUS/FX/BATT-----
end of battery menu
UP TOP STATUS
    
```

ERRORS

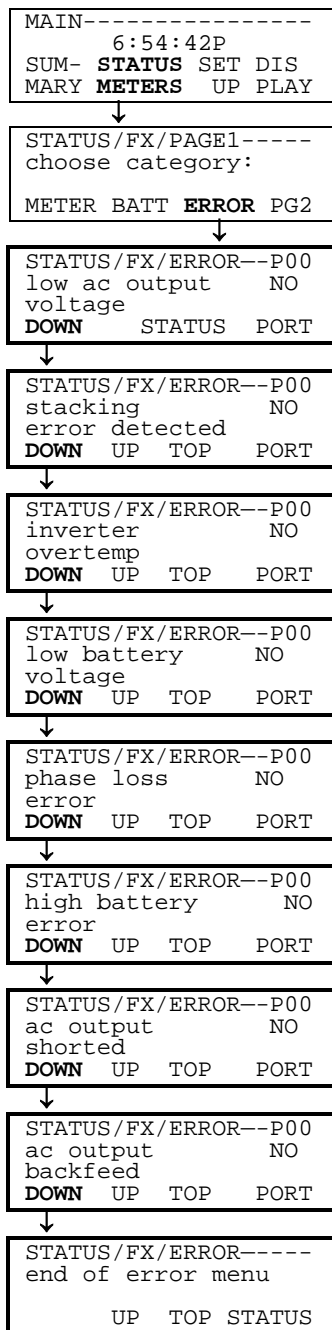

WARNINGS

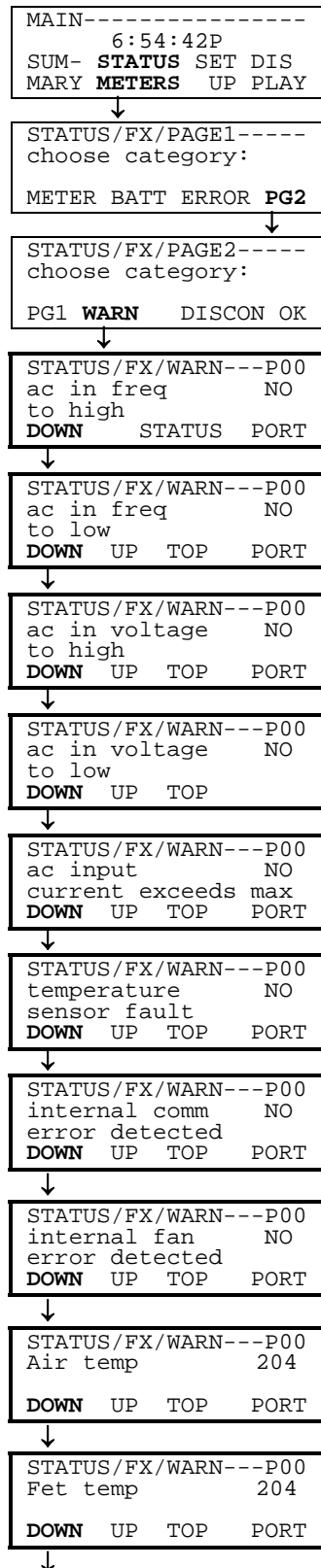

WARNINGS cont

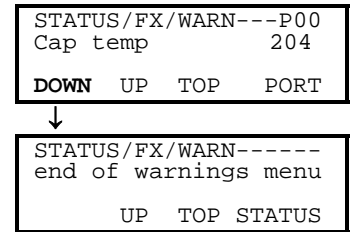

STATUS MENU

DISCONNECT REASONS

MAIN-----
6:54:42P
SUM- **STATUS** SET DIS
MARY **METERS** UP PLAY



STATUS/FX/PAGE1-----
choose category:
METER BATT ERROR **PG2**



STATUS/FX/PAGE2-----
choose category:
PG1 **WARN** DISCON OK



STATUS/FX/DISCON-P00
ac in freq NO
to high
DOWN STATUS PORT



STATUS/FX/DISCON-P00
ac in freq NO
to low
DOWN STATUS PORT



STATUS/FX/DISCON-P00
ac in voltage NO
> max
DOWN UP TOP PORT



STATUS/FX/DISCON-P00
ac in voltage NO
< min
UP TOP PORT



STATUS/FX/ERROR-----
end of error menu
UP TOP STATUS

SETUP MENU

SEARCH

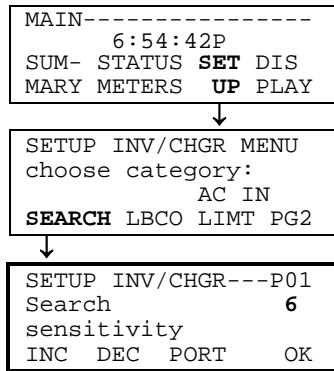

LBCO

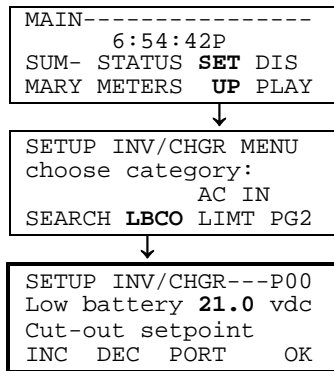

AC IN LIMIT

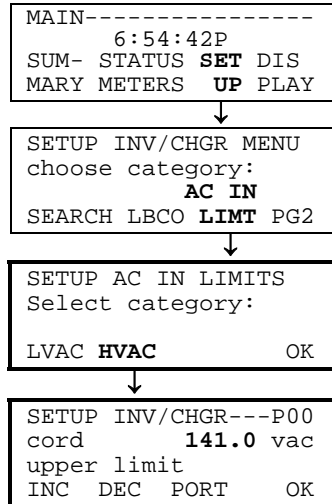
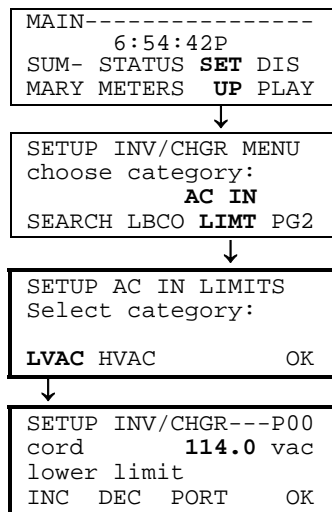

EQ

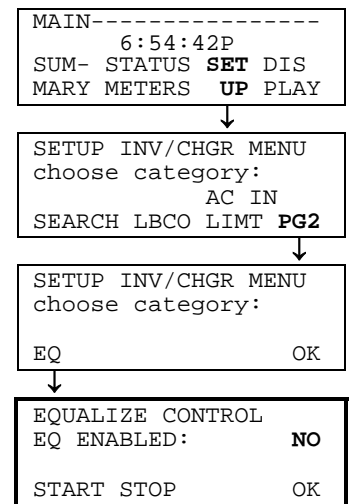

MAIN MENU SHORTCUT

Pressing the left two keys on the MATE at the same time from anywhere in the menu system takes you to the MAIN menu

DISPLAY MENU

BACKLIGHT

```
MAIN-----
 6:54:42P
SUM- STATUS SET DIS
MARY METERS UP PLAY
```



```
SETUP DISPLAY-----
MATE CODE REV: 330
CHOOSE CATEGORY:
BLITE TIME COMM OK
```



```
SETUP BLITE-----
Backlight controls
LEVEL MODE TIME OK
```

DATE / TIME

```
MAIN-----
 6:54:42P
SUM- STATUS SET DIS
MARY METERS UP PLAY
```



```
SETUP DISPLAY-----
MATE CODE REV: 330
CHOOSE CATEGORY:
BLITE TIME COMM OK
```



```
SETUP/MATE/CLOCK----
 Tu 12/10/02
 4:00:22P
DATE TIME OK
```

COMM

SET

```
MAIN-----
 6:54:42P
SUM- STATUS SET DIS
MARY METERS UP PLAY
```



```
SETUP DISPLAY-----
MATE CODE REV: 330
CHOOSE CATEGORY:
BLITE TIME COMM OK
```



```
SETUP/MATE/COMM-----
choose category:
BACK RE POLL PC DEBUG
```

MAIN MENU SHORTCUT

Pressing the left two keys on the MATE at the same time from anywhere in the menu system takes you to the MAIN menu

ADVANCED MENU--FX

INVERTER

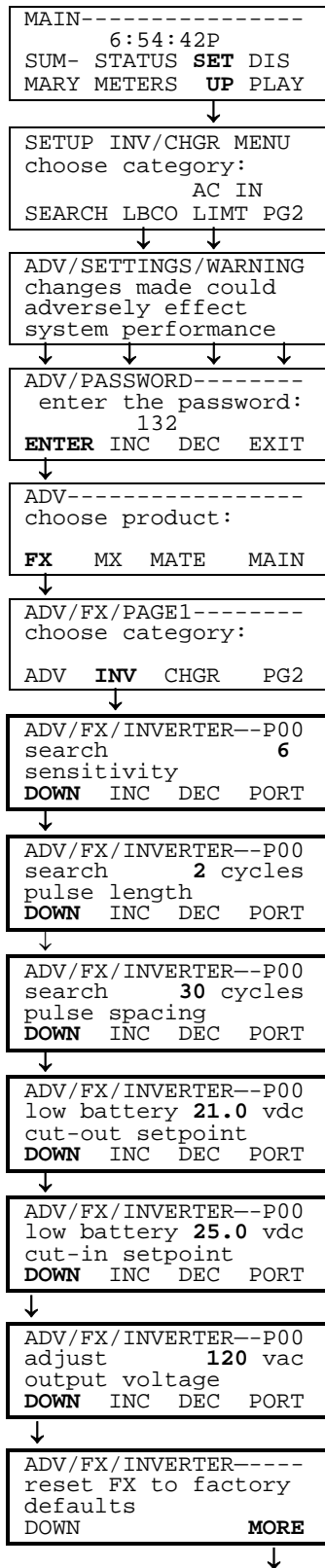

INVERTER cont

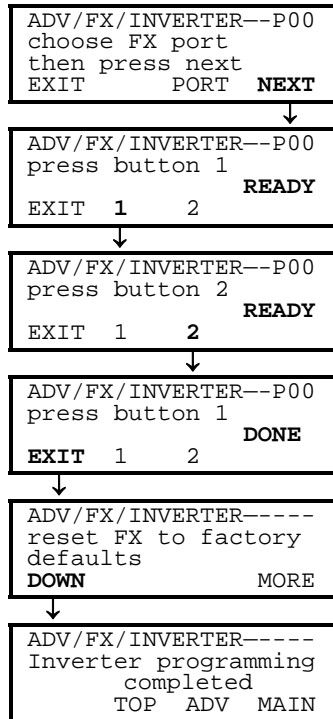

CHARGER

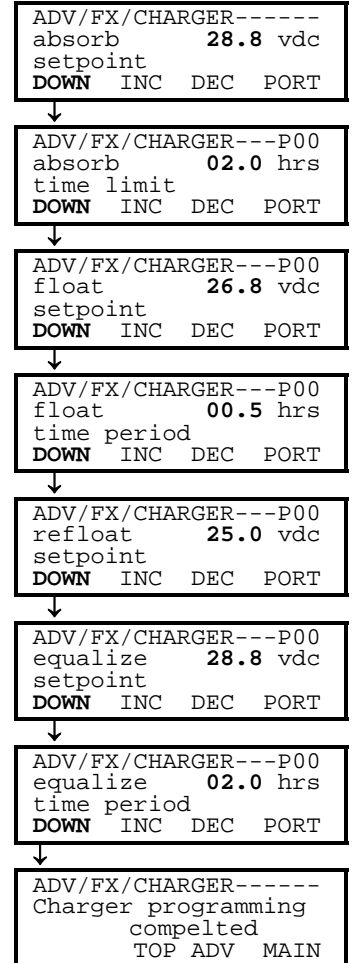
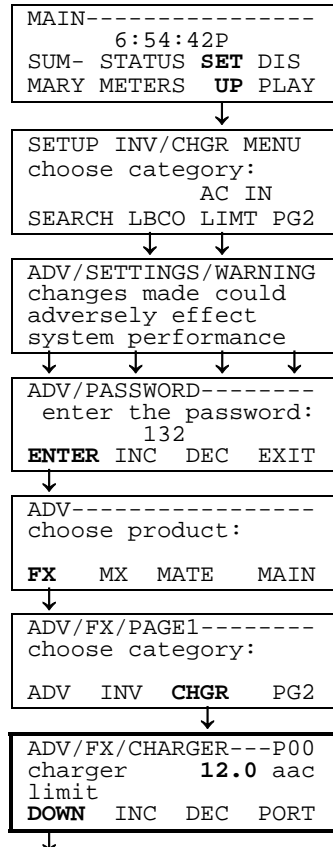

ADVANCED MENU—FX

CORD

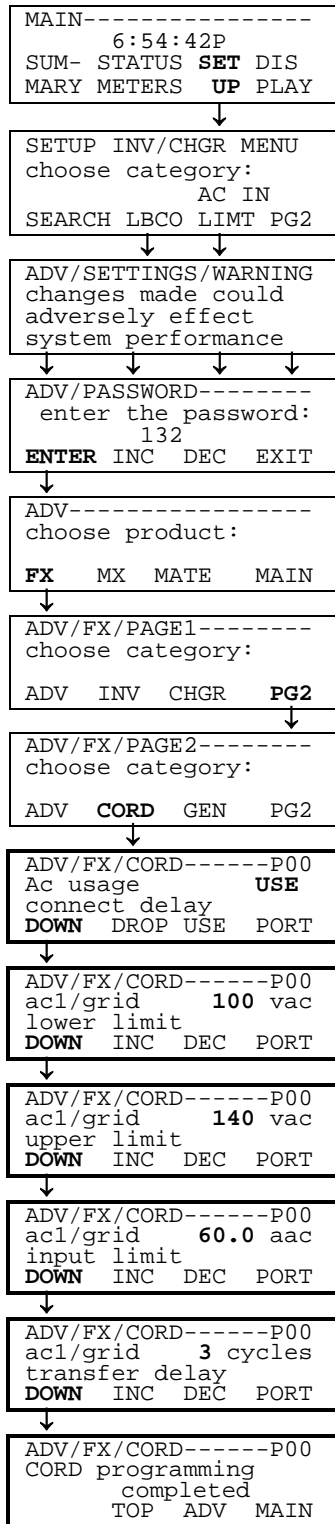

GEN

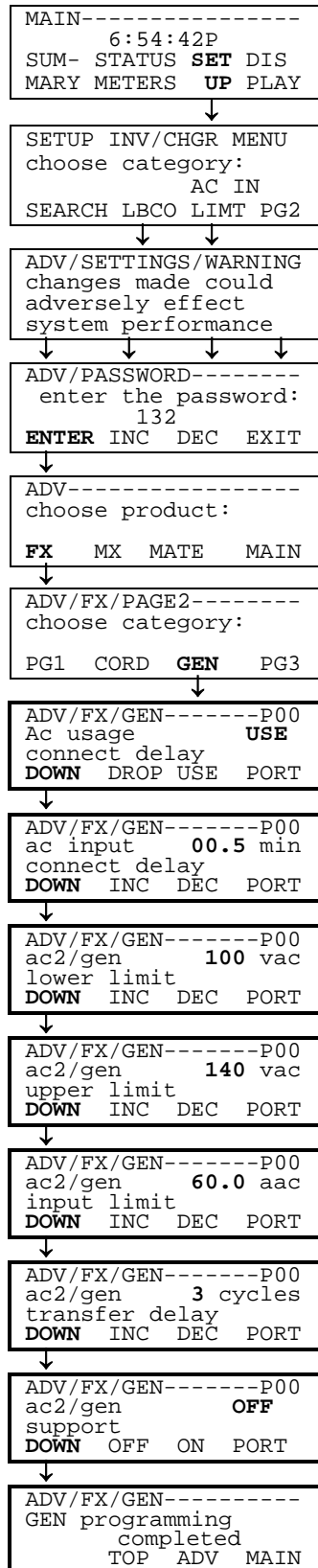

AUX OUTPUT

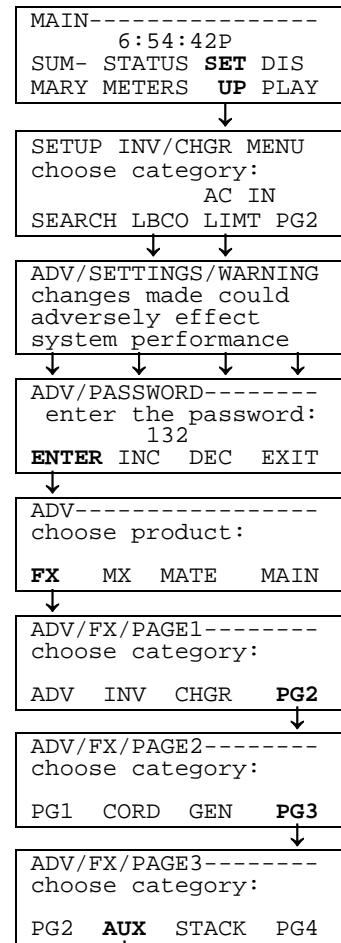

cont on next page

AUX OUTPUT cont

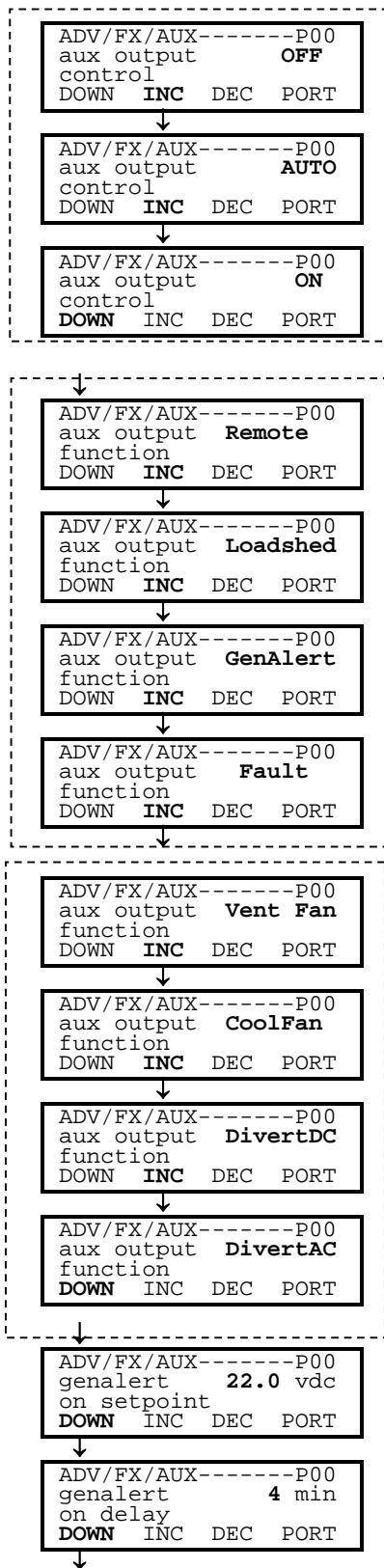

AUX OUTPUT cont

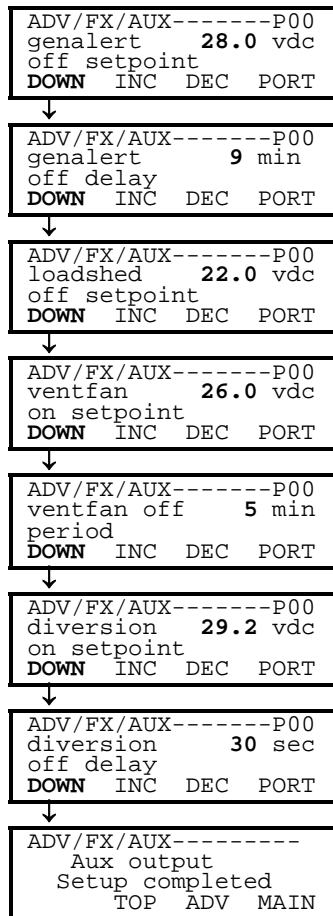

STACKING cont

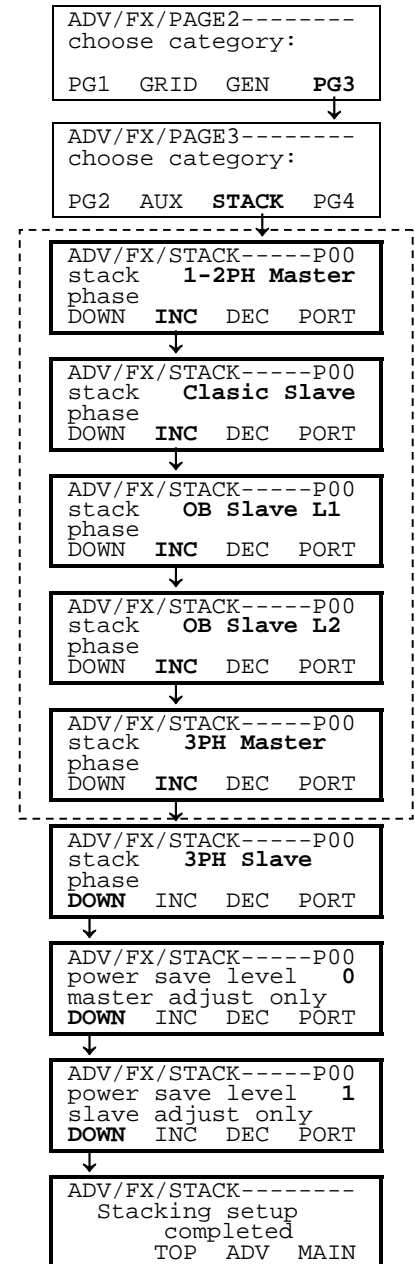

STACKING

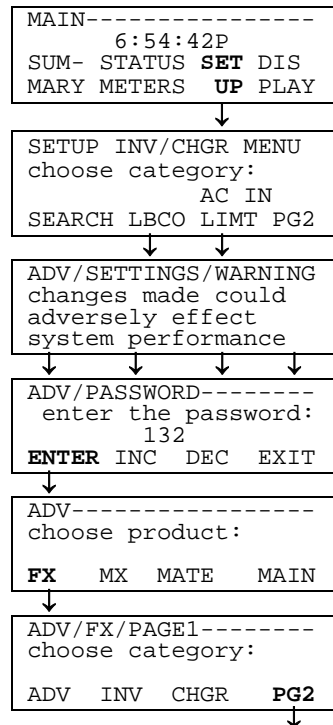

ADVANCED MENU--FX

CAL

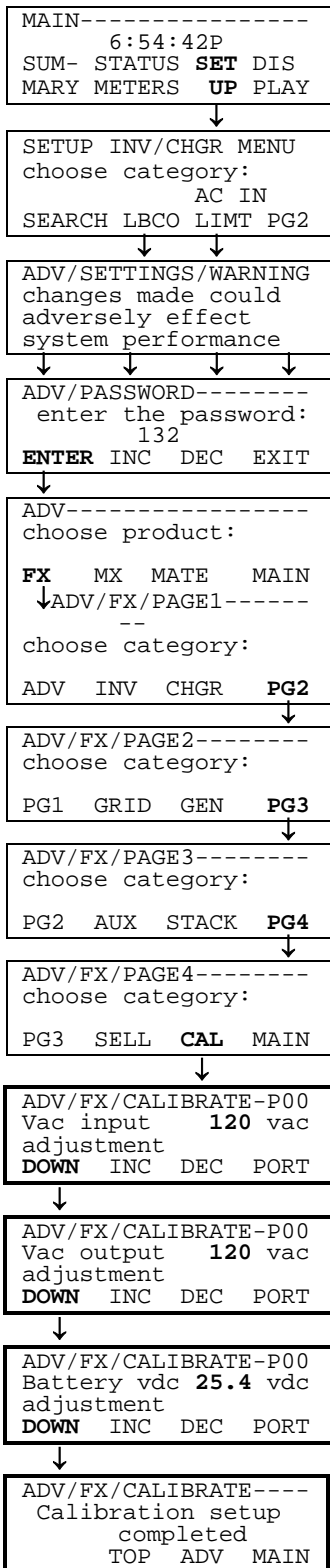

MAIN MENU SHORTCUT

*Pressing the left two keys on the MATE
at the same time from anywhere in the
menu system takes you to the MAIN menu*

ADVANCED MENU--MX

AUX

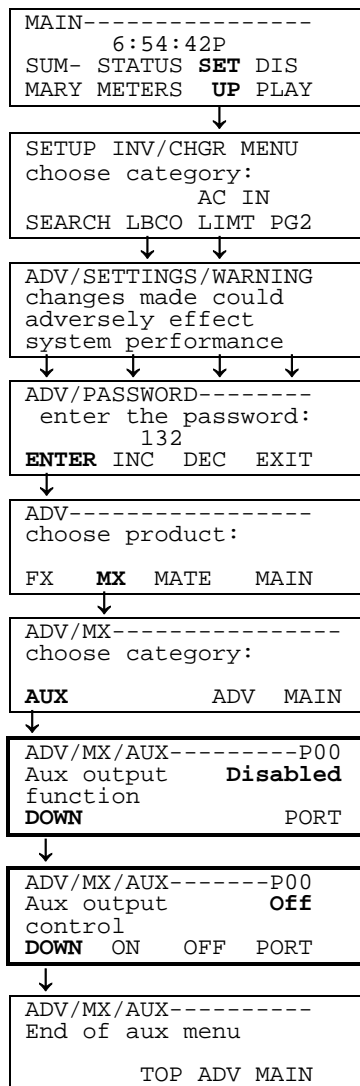

MAIN MENU SHORTCUT

*Pressing the left two keys on the MATE
at the same time from anywhere in the
menu system takes you to the MAIN menu*

ADVANCED MENU--MATE

AGS SETUP

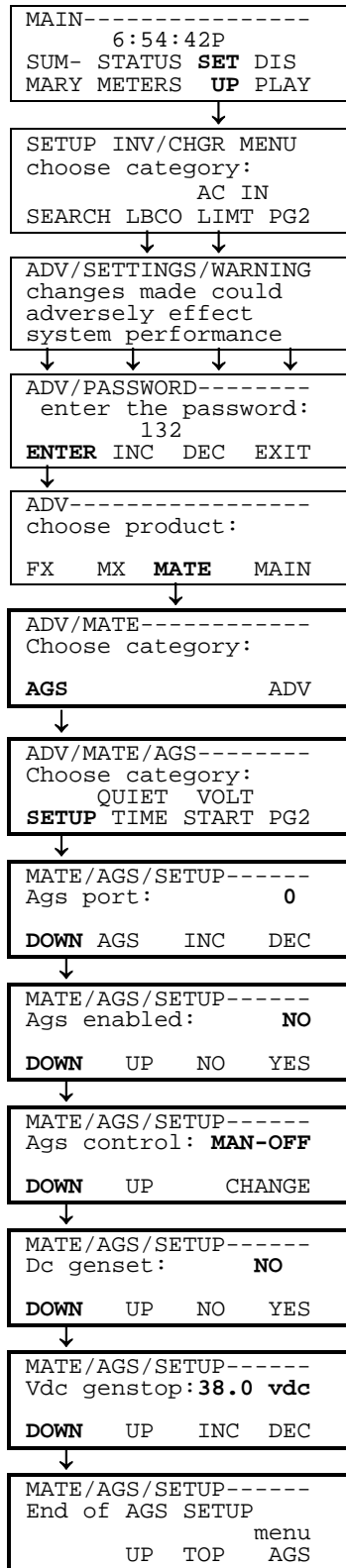

QUIET TIME

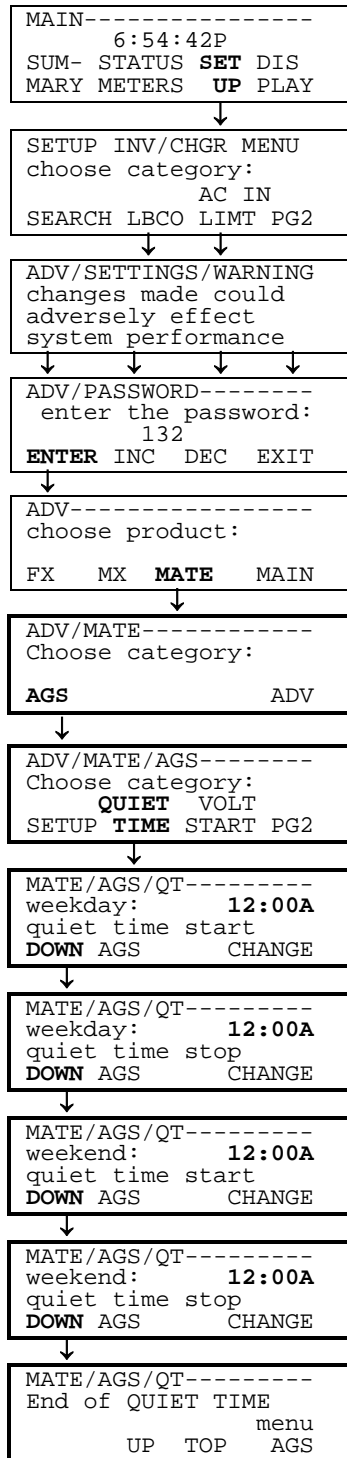

VOLTAGE START

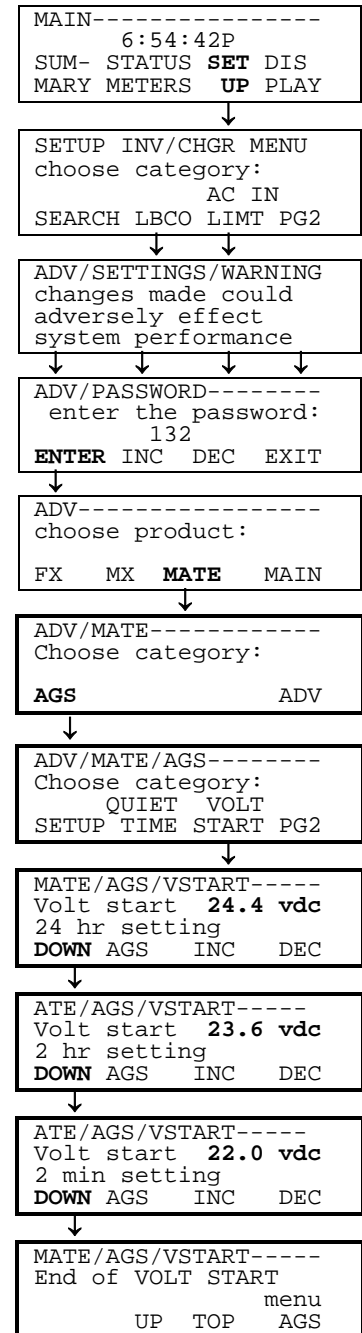

LOAD START

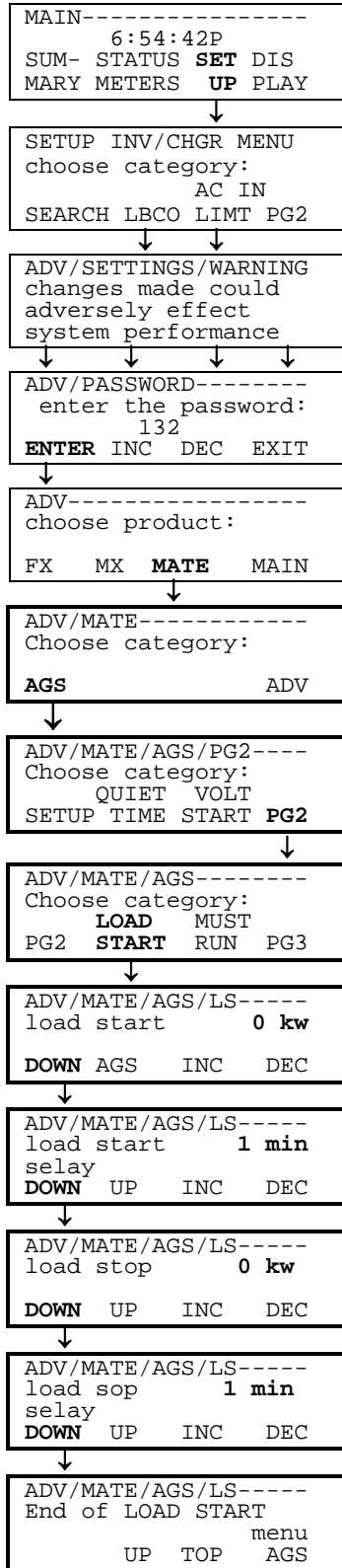

MUST RUN

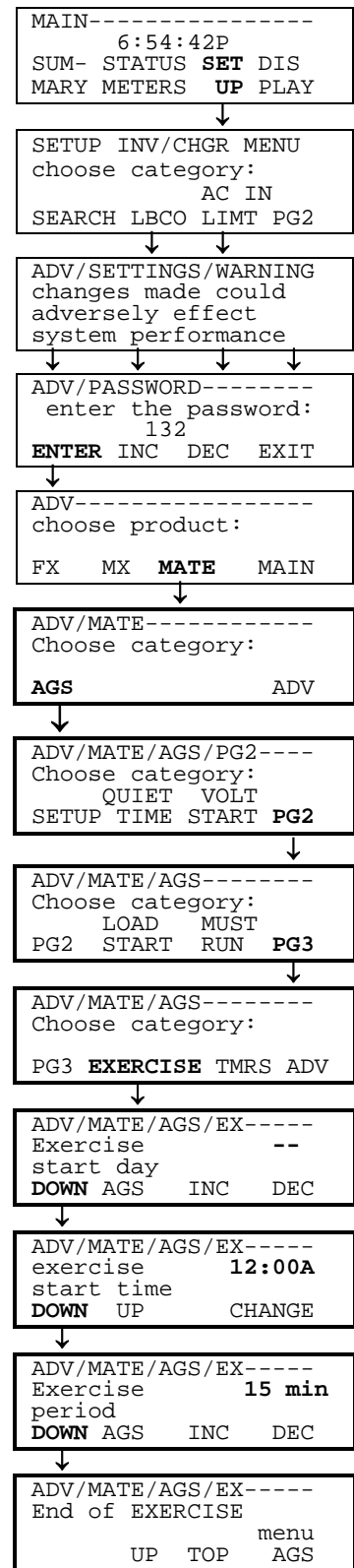
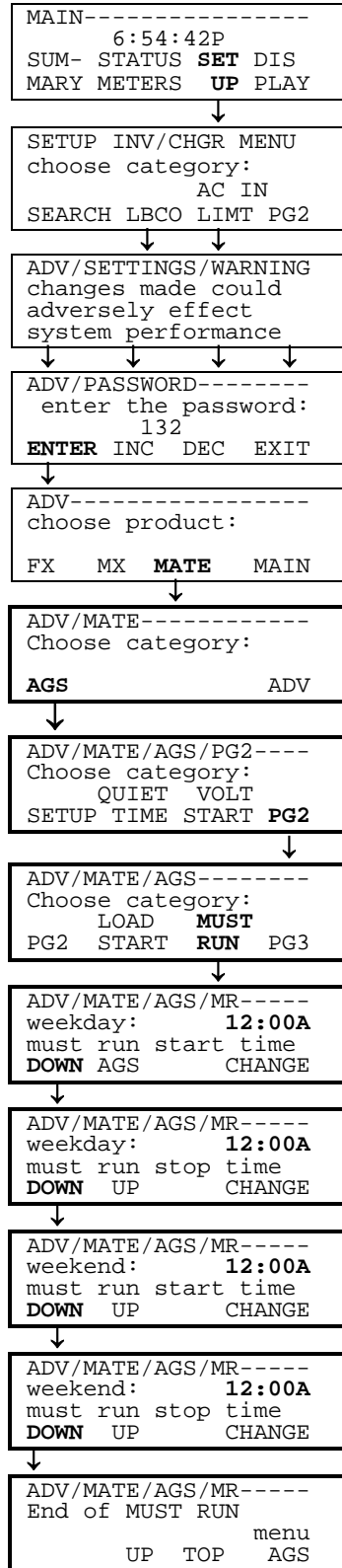

EXERCISE

TIMERS

TIMERS cont.

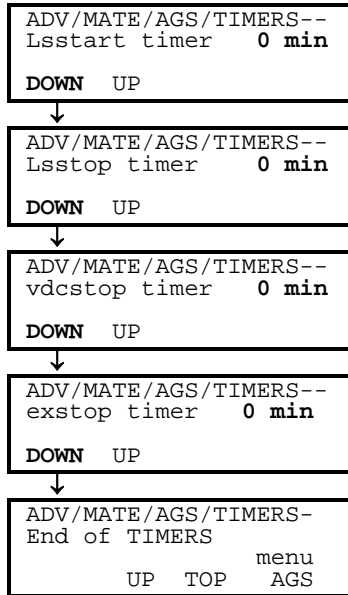
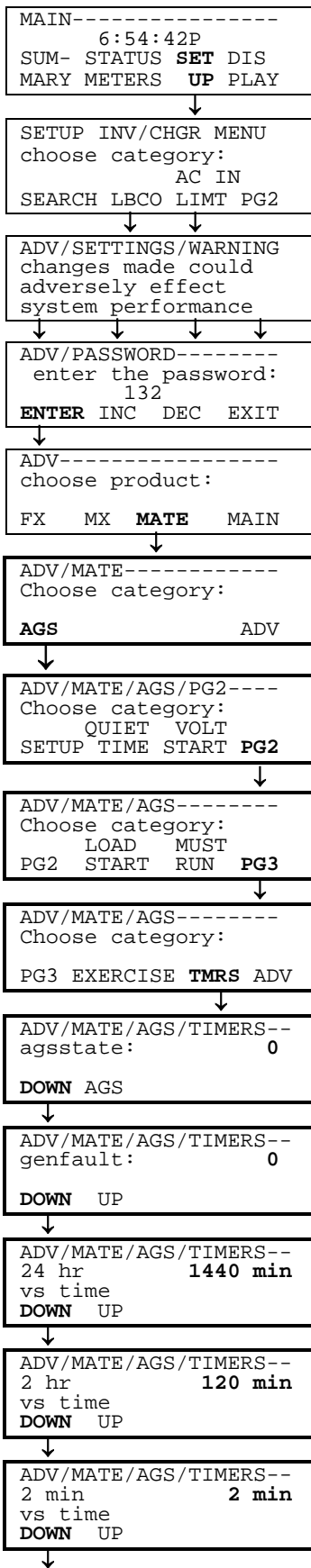

7.0 Menu Map Overview

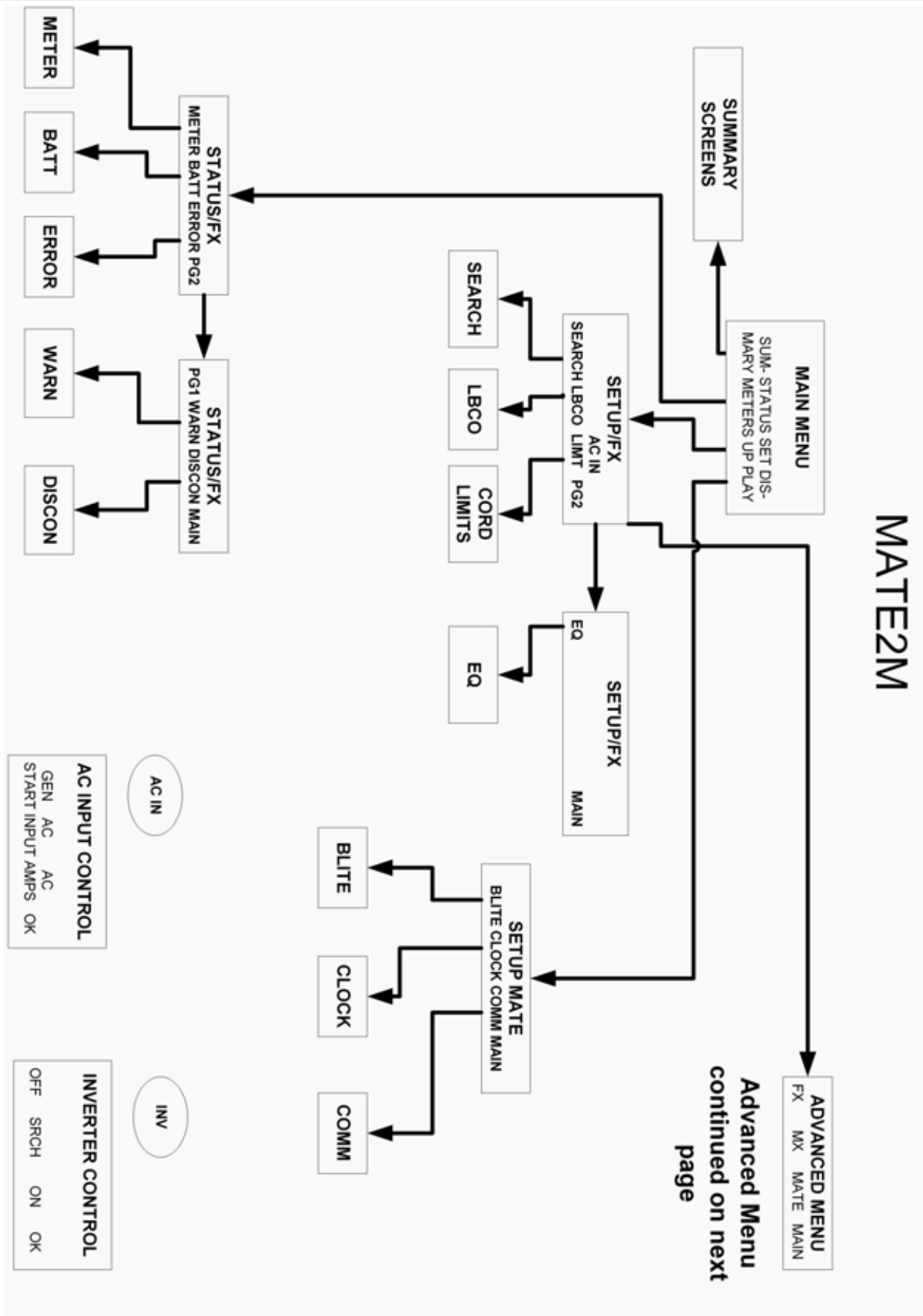

MATE2M

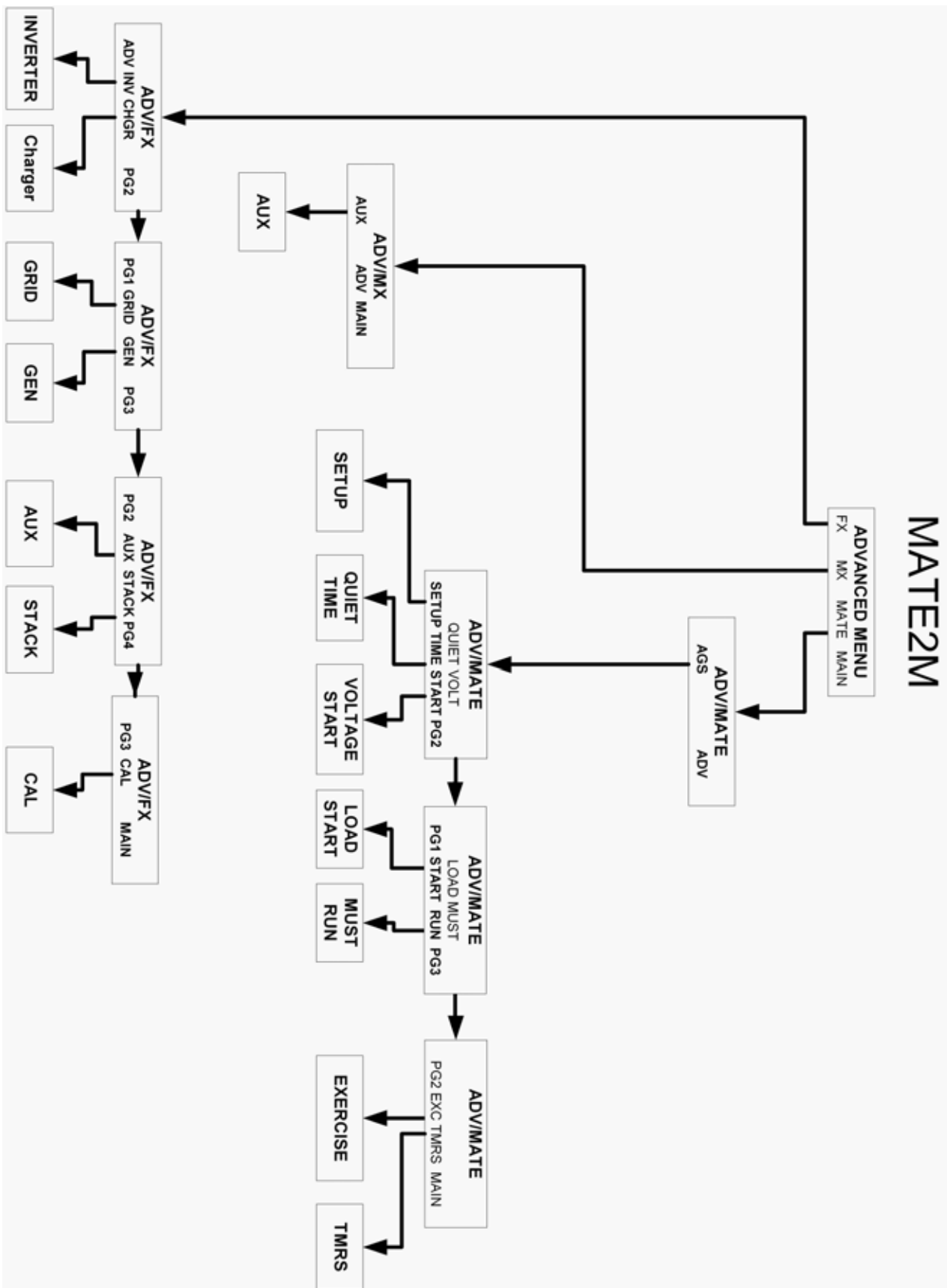

8.0 Troubleshooting

MATE2M does not power-up

The OutBack MATE2M is powered by the OutBack product that it is connected to. Make sure that all OutBack Products are powered-up and operating correctly before connecting the MATE2M. Check or replace the CAT5 cables running from the MATE2M to the OutBack product.

MATE2M does not find a Device

Make sure that all OutBack Products are powered-up and operating correctly before connecting the MATE2M. Check or replace the CAT5 cables running from the MATE2M to the OutBack product.

If a HUB is being used, make sure no OutBack products have been moved, unplugged, or added. If they have, follow the instructions in [MATE2M Setup Communications Options](#) to REPOLL for moved or new devices.

MATE2M does not display the correct meter or setting.

Make sure that all OutBack Products are powered-up and operating correctly before connecting the MATE2M. Check or replace the CAT5 cables running from the MATE2M to the OutBack product.

If a HUB is being used, make sure no OutBack products have been moved or unplugged. If they have, follow the instructions in [MATE2M Setup Communications Options](#) to REPOLL for moved or new devices.

MATE2M will not EQ my system when I use the EQ function under the <ACIN> button.

Older FXs and MXs with a newer MATE2M will not be able to utilize this system wide command. FXs that do not respond to this command can have an EQ cycle started by using the EQ start function located in the STATUS/FX/MODE menu. From the Main screen press **<STATUS>**, **<FX>**, **<MODES>**. Continue to press **<DOWN>** until you see the EQ function. If a HUB is used, FXs must have an EQ cycle start individually for each FX on the HUB (Use the **<PORT>** button to cycle through the available FXs).

MATE2M displays a 'COMM ERROR'

If the MATE2M receives too many interrupted or corrupt communications with OutBack products attached to the HUB, it will display a 'COMM ERROR' screen.

Choosing 'VIEW DEBUG' takes you to a screen that lists all ports and accumulated errors. Any Port experiencing errors can be found by the error count after the Port number.

In the example to the right, Port 4 has a large number of errors detected (04:025 means Port 4: showing 25 errors).

00:000	01:000	02:000
03:000	04:025	05:000
06:000	07:000	08:000
09:000	10:000	2M:000

Pressing any key will take you to the SETUP/MATE/COMM screen, which will allow the error counts to be reset using the 'RSET' button, the Debug screen can be redisplayed by using the 'VIEW' button, or user can get back to the SETUP menu by using the 'BACK' button.

Use the information on the Debug screen to locate the problem device. Make sure that it's DC breaker is on, and that it is operating correctly. Check or replace CAT5 cables running from the HUB to that device.

OutBack Power Systems

Two Year Limited Warranty

OutBack Power Systems Inc. warrants that the products it manufacturers will be free from defects in materials and workmanship for a period of two (2) years subject to the conditions set forth below.

The limited warranty is extended to the original user and is transferable. The limited warranty term begins on the date of invoice to the original user of the product. The limited warranty does not apply to any product or part thereof damaged by a) alteration or disassembly, b) accident or abuse, c) corrosion, d) lightning, e) reverse polarity, f) repair or service provided by an unauthorized repair facility, g) operation or installation contrary to instructions pertaining to the product.

OutBack Power Systems' liability for any defective product or any part thereof shall be limited to the repair or replacement of the product, at OutBack Power Systems' discretion. OutBack Power Systems does not warrant or guarantee the workmanship performed by any person or firm installing its products.

THIS LIMITED WARRANTY GIVES YOU SPECIFIC LEGAL RIGHTS, AND YOU MAY ALSO HAVE OTHER RIGHTS THAT VARY FROM STATE TO STATE (OR JURISDICTION TO JURISDICTION). OUTBACK POWER SYSTEMS' RESPONSIBILITY FOR MALFUNCTIONS AND DEFECTS IN HARDWARE IS LIMITED TO REPAIR AND REPLACEMENT AS SET FORTH IN THIS LIMITED WARRANTY STATEMENT. ALL EXPRESS AND IMPLIED WARRANTIES FOR THE PRODUCT, INCLUDING BUT NOT LIMITED TO ANY IMPLIED WARRANTIES OF AND CONDITIONS OF MERCHANTABILITY AND FITNESS FOR A PARTICULAR PURPOSE, ARE LIMITED IN DURATION TO THE LIMITED WARRANTY PERIOD SET FORTH ABOVE AND NO WARRANTIES, WHETHER EXPRESS OR IMPLIED, WILL APPLY AFTER SUCH PERIOD. SOME STATES (OR JURISDICTIONS) DO NOT ALLOW LIMITATIONS ON HOW LONG AN IMPLIED WARRANTY LASTS, SO THE ABOVE LIMITATION MAY NOT APPLY TO YOU.

OUTBACK POWER SYSTEMS DOES NOT ACCEPT LIABILITY BEYOND THE REMEDIES SET FORTH IN THIS LIMITED WARRANTY STATEMENT OR LIABILITY FOR INCIDENTAL OR CONSEQUENTIAL DAMAGES, INCLUDING WITHOUT LIMITATION ANY LIABILITY FOR PRODUCTS NOT BEING AVAILABLE FOR USE. SOME STATES (OR JURISDICTIONS) DO NOT ALLOW THE EXCLUSION OR LIMITATION OF INCIDENTAL OR CONSEQUENTIAL DAMAGES, SO THE ABOVE EXCLUSION OR LIMITATION MAY NOT APPLY TO YOU.

During the two year period beginning on the invoice date, OutBack Power Systems will repair or replace products covered under this limited warranty that are returned to OutBack Power Systems' facility or to an OutBack Power Systems authorized repair facility, or that are repaired on site by an OutBack Power Systems authorized repair technician. To request limited warranty service, you must contact OutBack Power Systems at 360-435-6030 within the limited warranty period. If limited warranty service is required, OutBack Power Systems will issue a Return MATERIAL Authorization (RMA) Number. Mark the outside of the package with the RMA number and include a copy of the purchase invoice in the package. You must ship the products back to OutBack Power Systems in their original or equivalent packaging, prepay shipping charges, and insure the shipment or accept the risk of loss or damage during shipment. OutBack Power Systems will ship the repaired or replacement products to you freight prepaid if you use an address in the continental United States, where applicable. Shipments to other locations will be made freight collect.

REGISTER YOUR PRODUCTS!

Your purchase of an OutBack Power Systems product is an important investment. Registering your products will help us maintain the standard of excellence you expect from us in terms of performance, quality and reliability.

Please take a moment to register and provide us with some important information.

Name: _____

Address: _____

City, State, Zip Code: _____

Country: _____

Telephone Number: _____

E-mail: _____

Sold by: _____

Installer: _____

Purchase Date: _____

Model Number: _____

Serial Number: _____

Circle all that apply:

Off-Grid Installation

Residential Installation

North America Location

Utility Connected Installation

Commercial Installation

Other _____

EXTENDED WARRANTY APPLICATION

OutBack Power Systems offers an optional three year extension to the standard two year limited warranty. Purchase of extended warranty coverage is available on products listed below provided conditions shown are met. Extended warranty coverage must be purchased within 90 days of the original sale of the product covered.

PRODUCT	REQUIRED SURGE PROTECTION	EXTENDED WARRANTY COST
FX2024	AC Input; AC Output, DC Input	\$300.00
FX2048	AC Input; AC Output, DC Input	\$300.00
MX60	DC Input; DC Output	\$100.00
MATE2M	NA	\$50.00
HUB 4	NA	\$35.00
HUB 10	NA	\$50.00

<u>Product Covered</u>	<u>Serial Number</u>	<u>Quantity</u>	<u>Extended Warranty Cost</u>
_____	_____	_____	_____
_____	_____	_____	_____
_____	_____	_____	_____

Total _____

Send check or money order payable to OutBack Power Systems. Include a completed copy of this application and send to:

OutBack Power Systems
 Extended Warranty Program
 19009 62nd Ave NE
 Arlington WA 98223 USA